



OZ Optics

shop.ozoptics.com
www.ozoptics.com

219 Westbrook Road
Ottawa, ON, Canada, K0A 1L0

Toll free: 1-800-361-5415
Telephone: 1-613-831-0981
Fax: 1-613-836-5089
sales@ozoptics.com

HIGH POWER SHUTTERS AND SAFETY INTERLOCKS

Features:

- Multiple Watt CW power handling
- Shutter speeds of < 5 msec
- Controlled via a 5 Volt TTL Signal
- Available with temperature and connector proximity sensors for safety interlocks
- Compatible with SMA 905 and FC connectors, including high power air gap style connectors
- Available in laser-to-fiber and fiber-to-fiber versions
- Fiber connector and receptacles with safety sensor/interlocks available
- Proximity sensor uses inexpensive, simple concept
- Easily adapted to existing fiber optic product lines
- Suitable for custom design into customer's fiber optic products

Applications:

- All situations involving laser beams, including high power laser beams coupled into singlemode or multimode fibers
- Any laser facility requiring compliance to regulatory laser safety standards
- High power Industrial laser applications - Laser marking, cutting, welding
- Lasers used in medical applications - laser scalpel, eye surgery, tattoo removal
- High power laser physics
- High power spectroscopy
- OEM laser systems

Product Description:

In response to increasing demand for high power handling fiber optic components, OZ Optics has developed a series of fiber optic shutters and connectors that incorporate smart sensors for safety interlocks. These shutter systems can be incorporated in OZ Optics' line of high power handling components, including free-space-to-fiber and fiber-to-fiber coupling situations. For extreme power handling capabilities the shutters can also incorporate additional beam dumps and/or heat sinks to safely absorb the blocked laser power.

The key components that allow realization of smart shutters and safety interlocks are a series of proximity sensors and temperature sensors installed at suitable locations in the body of fiber optic assemblies. These provide the necessary electrical signals to alert the end user to take appropriate action. The way in which the proximity and temperature sensors are used in smart shutters and safety interlocks is best illustrated by the following application examples:

1. A customer is using FC or SMA mating sleeve to butt-couple 2 high power multimode fibers terminated with appropriate connectors. A sensor that is installed at the appropriate point in the FC or SMA mating sleeve will be able to detect the presence or absence of a connector metal ferrule. Thus, in case an operator unwittingly removes one of the high power fiber patchcords by unscrewing the FC or SMA connector, the sensor signal can be used by the customer to trigger a safety interlock or shut down of the laser. In addition, if a thermocouple or a thermistor has also been installed in the mating sleeve, and there has been some damage to one of the connectorized fiber endfaces that is causing light to reflect into the mating sleeve leading to local temperature rise, the signals from the thermistor can be used to alert the operator and/or initiate a safety interlock at the laser or laser shut down. Figure 1 shows an SMA sleeve-thru adapter with contact style sensor for fiber connector proving. Figures 2 and 3 show SMA and FC mating sleeves in which both the inductive proximity and temperature sensors have been installed.



Figure 1: Sleeve-Thru Adapter with contact sensor.

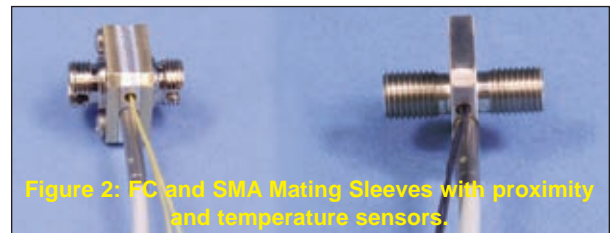

Figure 2: FC and SMA Mating Sleeves with proximity and temperature sensors.



Figure 3: FC Bulkhead Receptacle with contact sensors.



Figure 4: FC Bulkhead receptacle with proximity and temperature sensors.

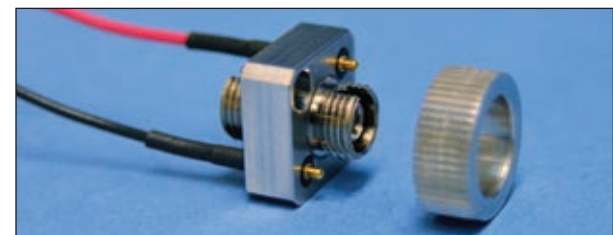

Figure 5: FC Sleeve-Thru Connector with "Pogo Pins."



Figure 6: FC Sleeve-Thru Connector with "Pogo Pins."

2. A customer is using OZ Optics shutter, built for use with high power applications, inclusive of beam-dump as shown in Figure 5. In case the beam-dump or inadequate heat sinking causes excessive heating of the shutter assembly, a temperature sensor signal can be used by the operator to initiate suitable actions (trigger alarm, safety interlock, laser shutdown etc.)

With this in mind we are able to offer the below listed products. These products are also easily adapted for incorporation by customers into their configurations. Furthermore, we also welcome the opportunity to custom-design smart shutters and safety interlocks for customer's applications.

Some examples of OZ Optics' standard parts installed with proximity and temperature sensors for use with shutters and safety interlocks:

- FC or SMA Bulkhead connectors (for free space to multimode fiber coupling situations) - See Figure 3
- Receptacle Style Collimators and Focusers (for free space to multimode fiber coupling situations)
- FC and SMA Sleeve-through adapters (mating sleeves) for multimode fiber to fiber coupling situations- See Figures 1 and 2
- Low power shutters installed in between FC receptacles involving metal beam blocker, no heat-dump - See Figure 4
- High power shutters involving reflectors to divert beam into beam-dump, with optional heat-sinking - See Figure 5
- Safety Interlocks triggered by any of the foregoing components

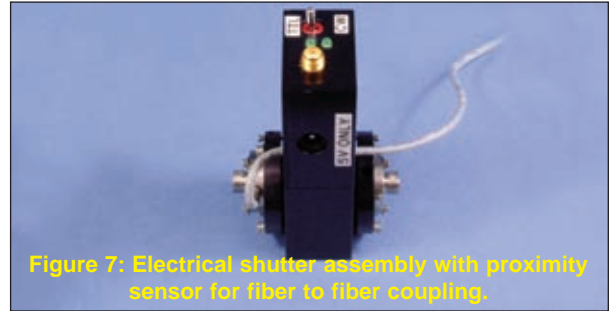

Figure 7: Electrical shutter assembly with proximity sensor for fiber to fiber coupling.

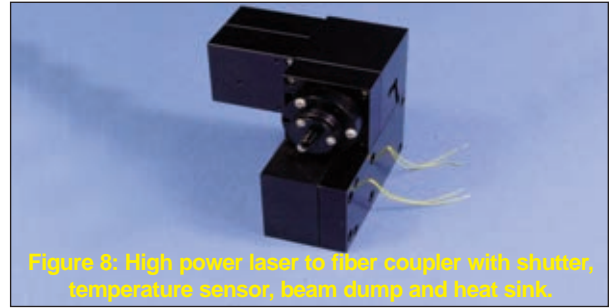

Figure 8: High power laser to fiber coupler with shutter, temperature sensor, beam-dump and heat sink.

Key Specifications:

- Insertion loss for matched pair MMF patchcords using mating sleeves: < 0.5 dB
- Power handling: up to 50 W for MMF patchcords using mating sleeves
- Shutter response speed: < 5 msec
- Shutter electrical interface: 5 V TTL
- Thermistor: 10 kohms NTC @ 25 °C
- Inductive proximity sensor: 3 mm OD, 0.6 mm operating distance, maximum operating temperature 60 °C
- Contact sensor: spring loaded POGO Electrical contacts to detect ferrule and nut

Part Numbers and Descriptions:

Description

Sensor Installed Receptacles

- X = Connector Code:
- 3 = NTT-FC (Compatible with FC Connectors with Flat, Super PC, or Ultra PC finishes, and high power FC connectors with flat endfaces, non-adjustable focus)
 - 3A = Angled FC (Either PC Finish or angled-flat (AFC) finish)
 - A3 = Adjustable focus NTT-FC (Compatible with Flat, Super PC, or Ultra PC finishes, and high power FC connectors with flat endfaces)
 - A3A = Adjustable Angled NTT-FC (Either PC Finish or angled-flat (AFC) finish)
 - 5 = SMA 905 or air gap high power SMA 905

Part Number

HPCR-X-F-(OPT)

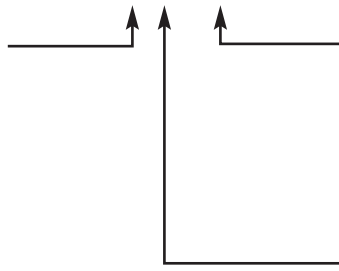

- OPT = Sensor Options:
- P = Proximity Sensor
 - T = Temperature Sensor
 - PT = Proximity and Temperature Sensors
 - C = Contact Type Sensor
 - CT = Contact Sensor and Temperature Sensor

- F = Fiber Type:
- S = Singlemode or Multimode
 - P = Polarization maintaining

Part Numbers and Descriptions:

Description

Sensor Installed Butt Joint Style Connectors

Part Number

AA-250-XY-(OPT)

XY = XY Input and output connector codes:
 3 = NTT-FC (Compatible with FC Connectors with Flat, Super PC, or Ultra PC finishes, or with high power, air-gap style FC connectors used with multimode fiber only).
 5 = SMA 905 or air gap high power SMA 905

OPT = Sensor Options:
 0 = No sensor
 P = Proximity Sensor
 T = Temperature Sensor
 PT = Proximity and Temperature Sensors
 C = Contact Type Sensor
 CT = Contact Sensor and Temperature Sensor

Part Numbers and Descriptions:

Description

Receptacle Style Shutters for Low and High Power Applications

Part Number

SH-200-XY-W-F-(OPT)-(BH)

XY = Input and output side connector receptacle codes:
 3 = FC (Compatible with Flat, Super PC and Ultra PC finishes)
 5 = SMA 905

W = Wavelength:

F = Fiber Type:
 M = Multimode
 S = Singlemode
 P = Polarization maintaining

BH = Beam-Dump and Heat-Sink options:
 0 = None
 BH = With built-in Beam-Dump and Heat Sink

OPT = Sensor Options:
 0 = No sensor
 P = Proximity Sensor
 T = Temperature Sensor
 PT = Proximity and Temperature Sensors
 C = Contact Type Sensor
 CT = Contact Sensor and Temperature Sensor

Part Numbers and Descriptions:

Description

Pigtail Style Shutters for Low and High Power Applications

Part Number

SH-200-W-a/b-F-XY-JD-L-(OPT)-(BH)

W = Wavelength: Specify in nanometers
a/b = Fiber core and cladding diameters in microns. See Tables 1 to 5 of the *Standard Tables* for fiber sizes available.

F = Fiber type:
 M = Multimode
 S = Singlemode
 P = Polarization maintaining

XY = Input and Output Connector Types:
 For non-high power connectors, please refer to Table 6 of the *Standard Tables* data sheet. For high power connectors, please contact OZ Optics.

BH = Beam-Dump and Heat-Sink options:
 0 = None
 BH = With built-in Beam-Dump and Heat Sink

OPT = Sensor Options:
 0 = No sensor
 P = Proximity Sensor
 T = Temperature Sensor
 PT = Proximity and Temperature Sensors
 C = Contact Type Sensor
 CT = Contact Sensor and Temperature Sensor

L = Fiber Length in meters

JD = Jacket Diameter
 3 = 3 mm OD PVC loose tube with Kevlar
 3A = 3 mm OD armored
 3AS = 3 mm OD stainless steel armored
 5A = 5 mm OD armored
 5AS = 5 mm OD stainless steel armored

See table 7 of the *Standard Tables* for drawings

Frequently Asked Questions (FAQs):

- Q:** Which of the OZ Optics' products are available with the connector and temperature sensors installed, can they be installed in other components?
- A:** Currently we can offer sleeve thru mating sleeves, FC and SMA receptacles, Laser to Fiber couplers, receptacle style collimators and focusers. As the sensors can be easily installed in other components, please contact OZ Optics for your custom application.
- Q:** What are the power handling limits?
- A:** In principle, this will be determined by the power handling capability of multimode fibers used and quality of the fiber end faces. For >5W power levels shutters can be designed with beam-dumps and suitable heat sinks.
- Q:** Are there any limitations on the fiber types?
- A:** The discussed technique is best suited for coupling situations involving multimode fibers. The core sizes can be different on the input and outputs but this can potentially lead to high insertion losses through core size (and fiber NA) mismatches.
- Q:** Does the connector sensor work with all connector types?
- A:** The connector sensor only works with connectors with metal ferrules (Typical for high power applications). Connectors with zirconia ferrules do not trigger the sensor.

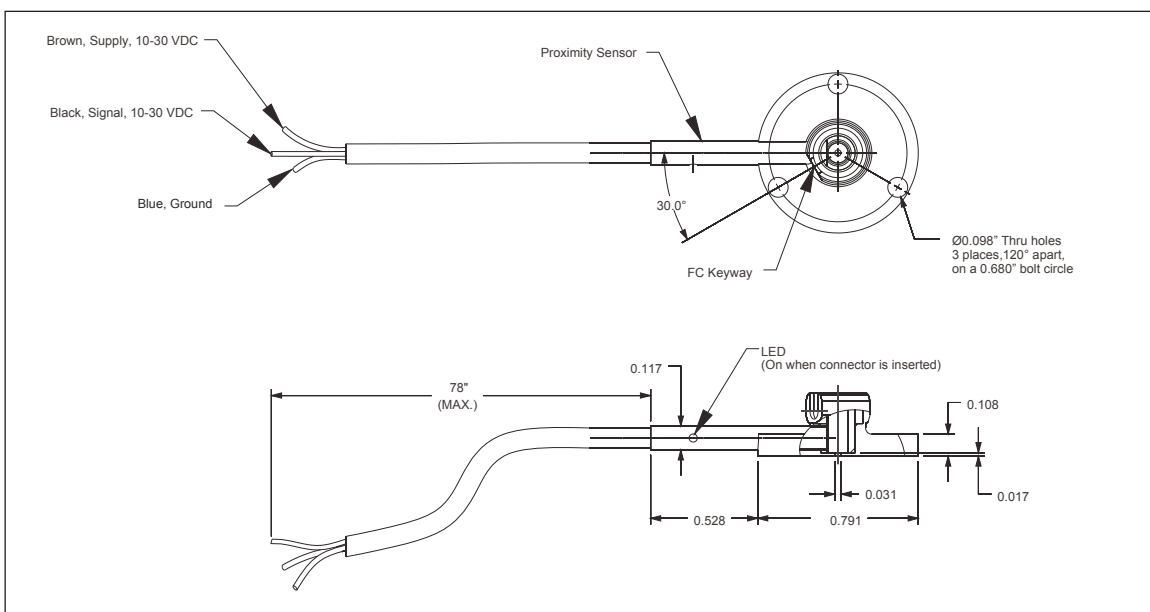

Figure 1: FC Receptacle with Proximity Sensor

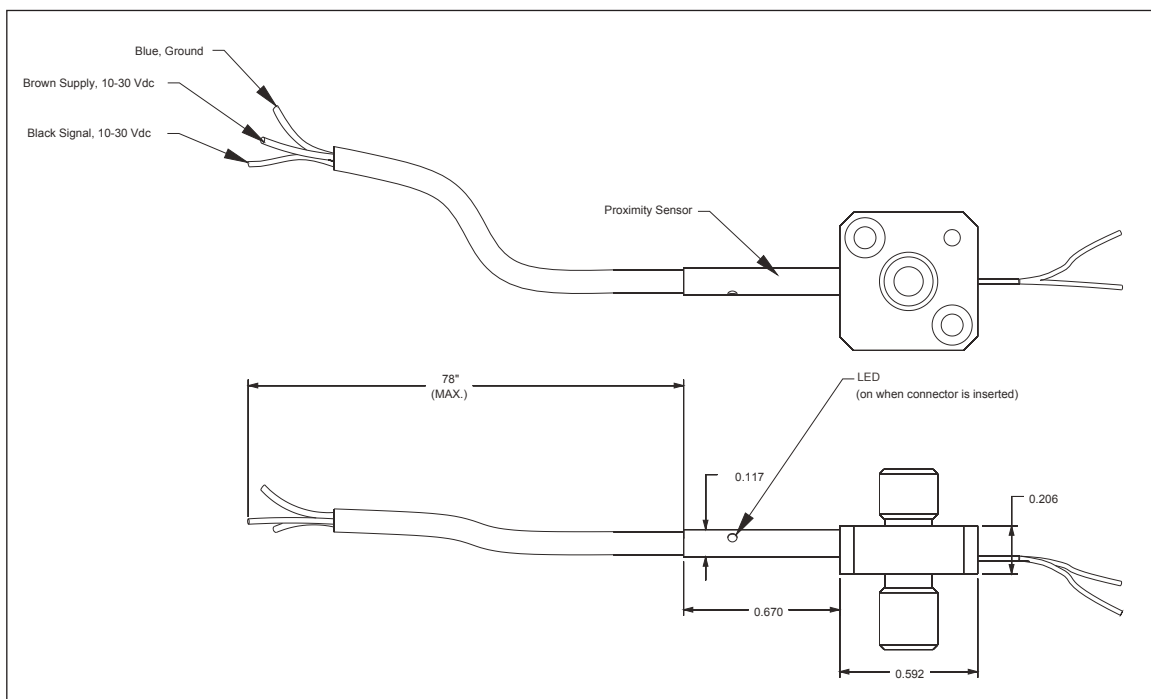

Figure 2: SMA Mating Sleeve with Proximity Sensor